

Product packaging logic diagram

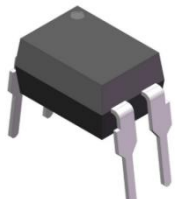

DIP4

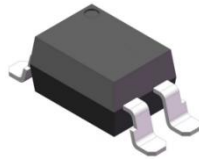

SMD4

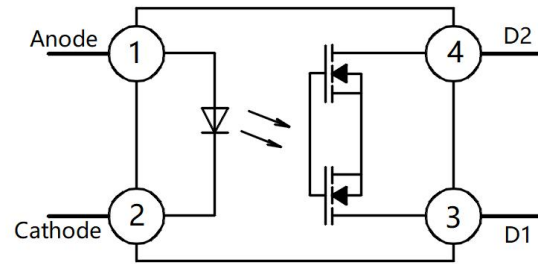

Pin Configuration

Features

- Normally open, single pole single throw
- Control 600VAC or DC voltage
- High isolation voltage between input and output ($V_{iso} = 5000V_{rms}$)
- High sensitivity, low ON resistance
- Low-level off-state leakage current
- Operating Temperature: $-40^{\circ}C \sim 85^{\circ}C$
- Environmentally friendly products, compliant with CQC, UL, and VDE requirements

Mechanical Data

- Case: DIP4、SMD4
- Molding Compound: UL Flammability Classification Rating 94V-0
- Terminals: Matte tin-plated leads; solder ability-per MIL-STD-202, Method 208

Applications

- Used for isolation and on-off control between main and control circuits of switching power supplies and industrial power modules, it achieves high-low voltage isolation and quickly triggers protection via signal transmission during overload or short circuit.
- Household Electric Appliances Applied to devices such as air conditioning, washing machines, smart homes, etc.
- Communication and Security: Switching signals in communication base stations and switches, and used for power control of monitoring cameras and access control systems.
- Medical equipment: Used for power management and signal processing of medical devices such as copiers and automatic disinfection equipment.



Ordering Information

XL 460A (X) (X) - (U) (N) (Y)
 ① ② ③ ④ ⑤ ⑥ ⑦

- ① Brand(XL)
- ② Product series(460A)
- ③ Package type(DIP4:None ,SMD4: A)
- ④ Halogen option(None :Halogen free)
- ⑤ Lead frame (None: Copper)
- ⑥ Customer option 1 (0-9 or A-Z or none)
- ⑦ Customer option 2 (0-9 or A-Z or none)

Part Number	Package	Shipping Quantity	Marking Code
XL460A	DIP4	100pcs/Tube	XL460
XL460AA	SMD4	2000pcs / Tape & Reel	XL460

Marking Information

- " XL" denotes brand.
- " 460A" denotes Product series.
- " Y" denotes Year : A(2024), B(2025), C(2026)
- " WW" denotes Week' s number .
- " N" denotes the day of Week.



Maximum Ratings (@ T_A = 25°C unless otherwise specified)

Parameter		Symbol	Value	Unit
Input	Forward Current	I _F	50	mA
	Peak Forward Current *1	I _{FP}	1	A
	Reverse Voltage	V _R	5	V
	Power Dissipation	P _D	75	mW
Output	Load Voltage (peak AC)	V _L	600	V
	Continuous load current (peak AC)	I _L	0.04	A
	Peak load current*2	I _{peak}	0.15	A
	Power Dissipation	P _{out}	500	mW

Thermal Characteristics

Parameter	Symbol	Value	Unit
Isolation Voltage *3	V _{ISO}	5000	V _{rms}
Operating Temperature	T _{OPR}	-40 ~ +85	°C
Storage Temperature Range	T _{STG}	-40 ~ +100	°C

Notes:

1. Pulse width ≤ 1μs, Duty ratio: 0.001
2. 100 ms (1 shot), V_L = DC
3. 40 to 60% RH, AC for 1 minute

Electrical Characteristics (@ T_A = 25°C unless otherwise specified)

Parameter		Symbol	Test Condition	Min.	Typ.	Max.	Unit
Input	LED turn on current	I _{Fon}	I _L =0.04A	-	0.4	3	mA
	LED turn off current	I _{Foff}	I _L =0.04A	0	0.3	-	mA
	LED dropout voltage	V _F	I _F =5mA	1	1.3	1.4	V
Output	On resistance	R _{on}	I _F =5mA, I _L =0.04A, Within 1s on time	-	36	120	Ω
	Off state leakage current	I _{Leak}	I _F =0mA, V _L =600V	-	-	1000	nA
Transfer Characteristics	Turn on time	T _{on}	I _F =5mA, I _L =0.04A	20	120	2000	us
	Turn off time	T _{off}	I _F =5mA, I _L =0.04A	10	350	1000	us
	I/O capacitance	C _{iso}	f=1MHz, V _B =0		0.8	1.5	pF
	Initial I/O isolation resistance	R _{iso}	500V DC	1,000	-	-	MΩ

Note:

Recommended LED Forward Current I_F=5 to 10mA.

Ratings and Characteristics Curves (@ $T_A = 25^\circ\text{C}$ unless otherwise specified)

Fig.1 Load current vs. Ambient temperature characteristics

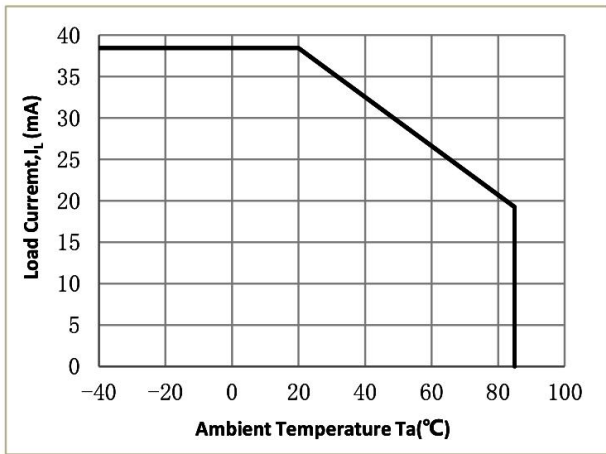

Fig.2 On resistance vs. Ambient temperature characteristics

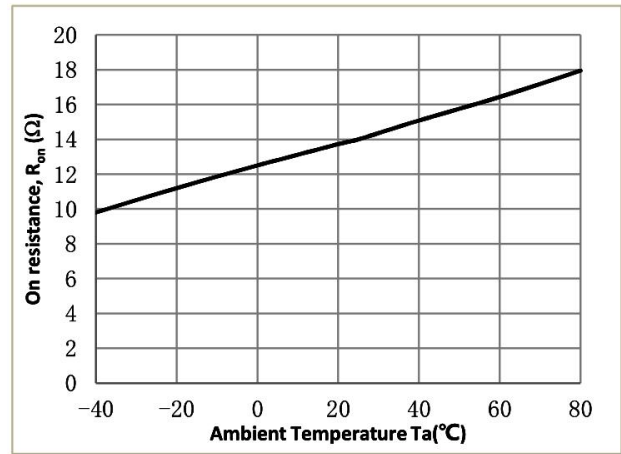

Fig.3 Turn on time vs. Ambient temperature characteristics

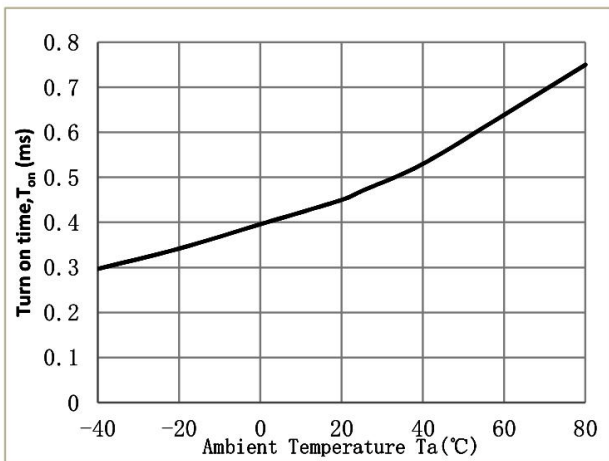

Fig.4 Turn off time vs. Ambient temperature characteristics

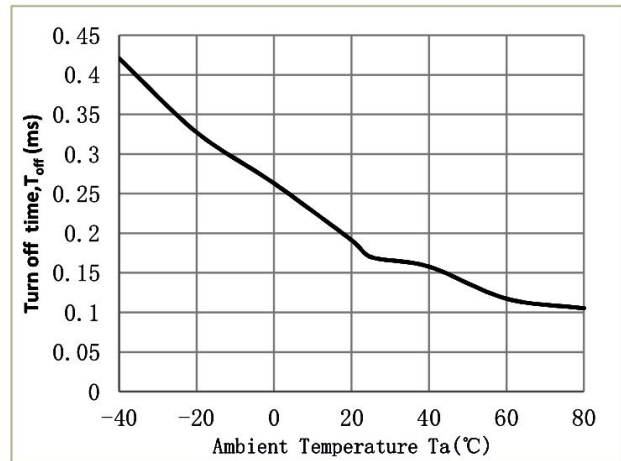

Fig.5 LED turn on current vs. Ambient temperature characteristics

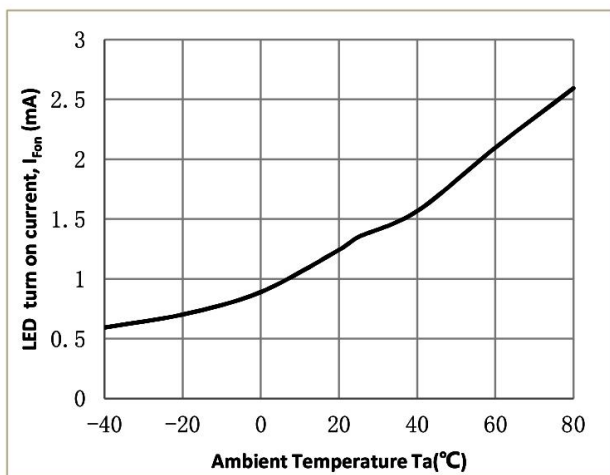
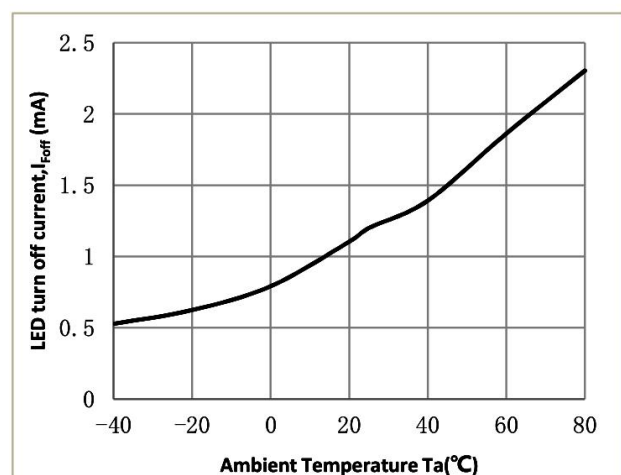

Fig.6 LED turn off current vs. Ambient temperature characteristics



Ratings and Characteristics Curves (@ $T_A = 25^\circ\text{C}$ unless otherwise specified)

Fig.7 LED dropout voltage vs. Ambient temperature characteristics

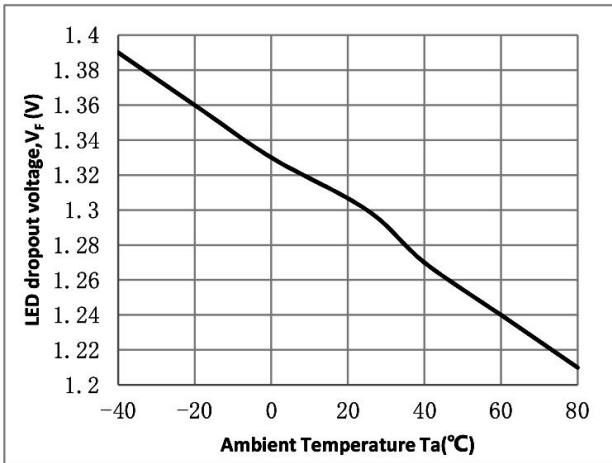

Fig.8 Output current vs Output voltage

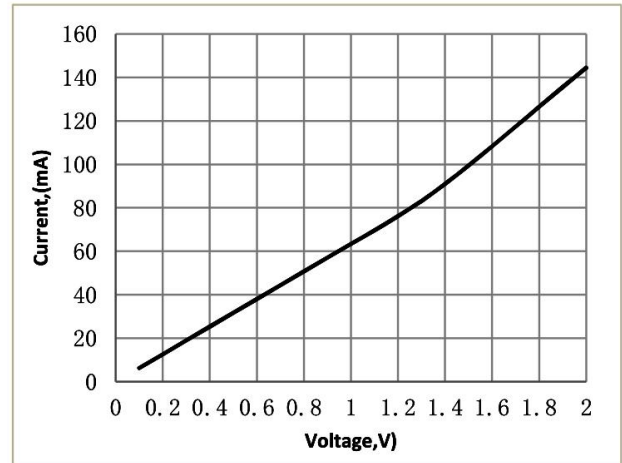

Fig.9 Off state leakage current vs Load voltage characteristics

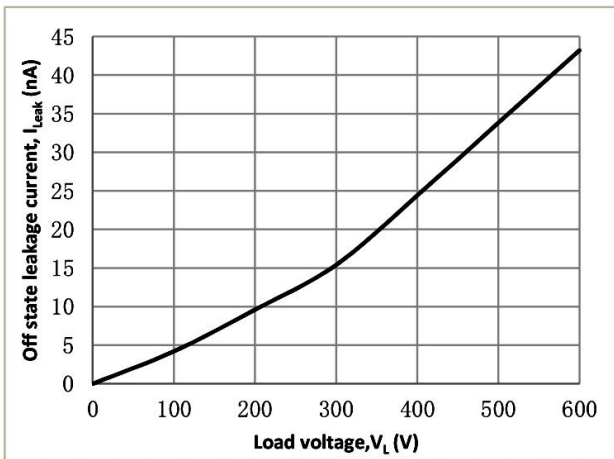

Fig.10 LED turn on time vs Forward current characteristics

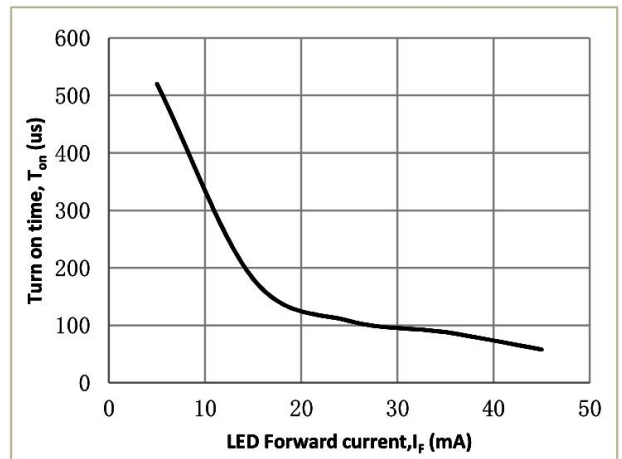

Fig.11 LED turn off time vs Forward current characteristics

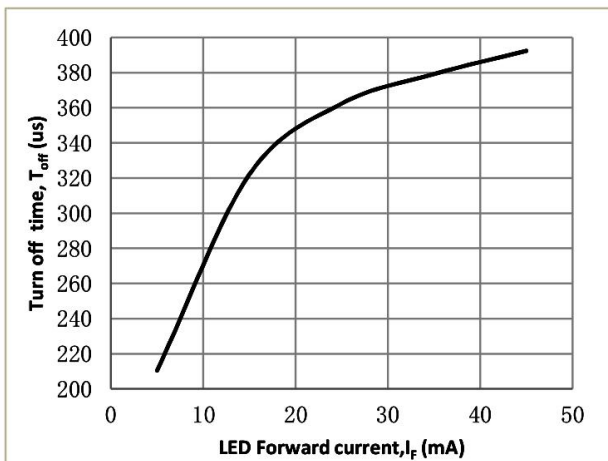
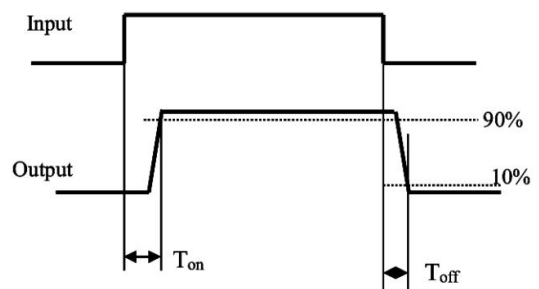
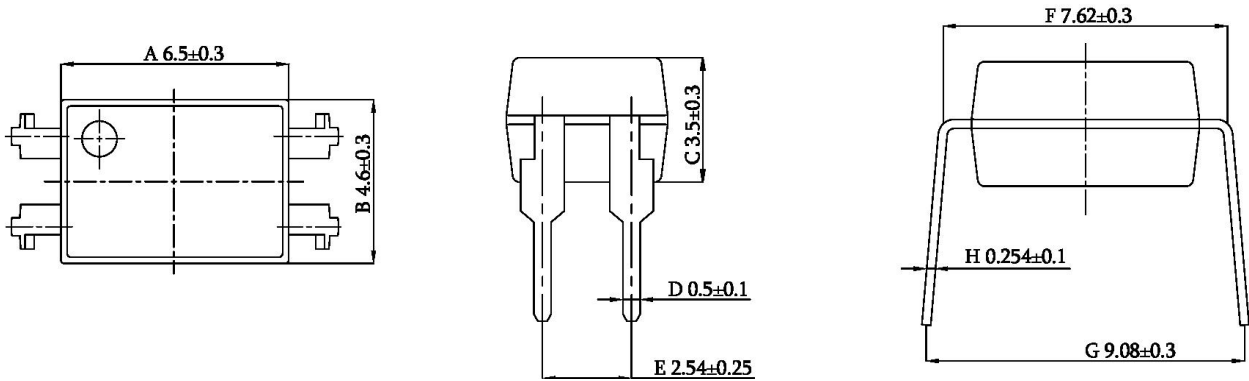

Fig.12 Turn on/off time



Package Outline Dimensions (unit: mm)

DIP4



SMD4

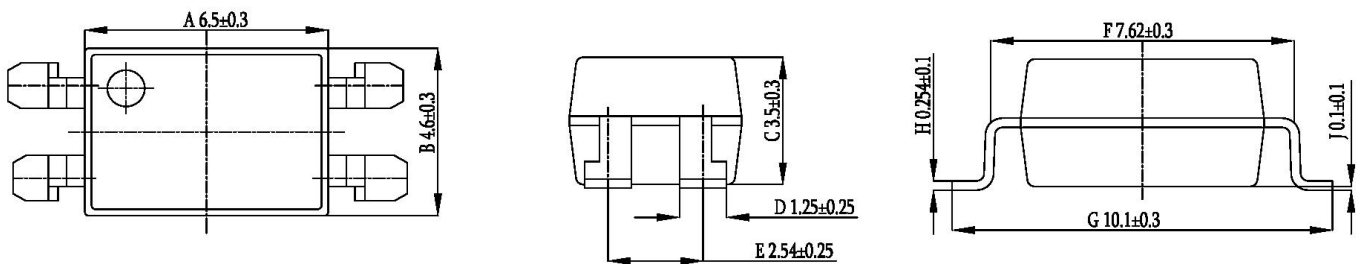

SOLDERING FOOTPRINT (unit: mm)

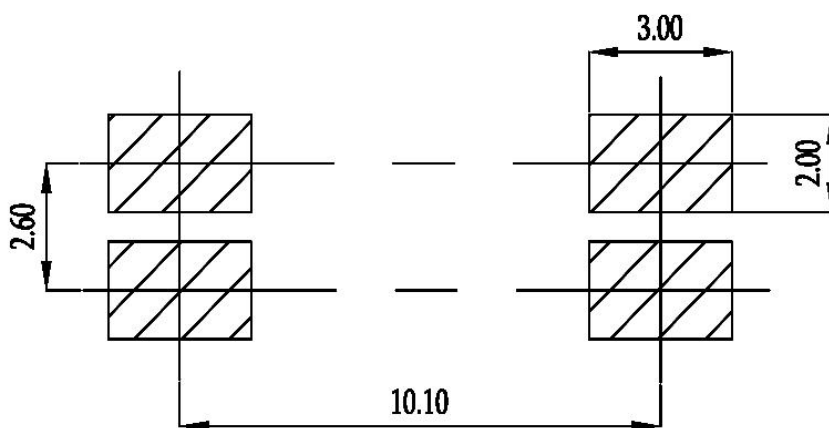

Reflow soldering

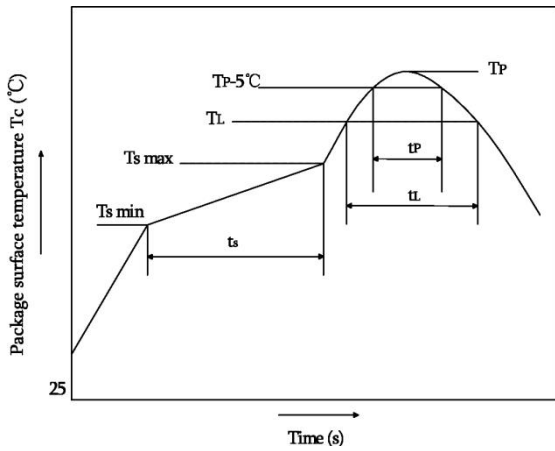

	Symbol	Min	Max	Unit
Preheat temperature	Ts	150	200	°C
Preheat time	ts	60	120	s
Ramp-up rate(T _L to T _P)			3	°C/s
Liquidus temperature	T _L	217		°C
Time above T _L	t _L	60	150	s
Peak temperature	T _P		260	°C
Time during which T _c is between (T _P -5) and T _P	t _p		30	s
Ramp-down rate(T _P to T _L)			6	°C/s

Note:

Reflow soldering is recommended at the temperatures and times shown, no more than three times.

Wave soldering

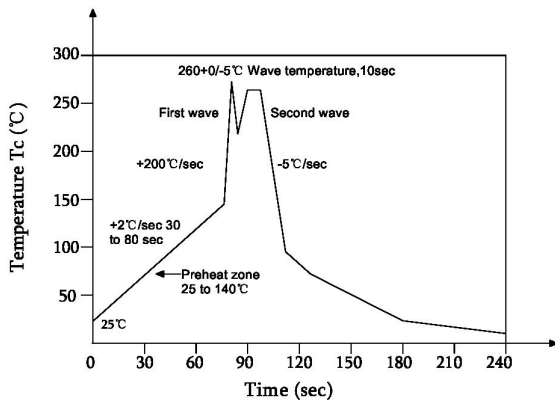

Profile feature	
Average ramp-up rate	~200°C/s
Heating rate during preheat	1°C/s to 2°C/s typical; 4°C/s maximum
Final preheat temperature Ts	~130°C
Preheat time (25°C to Ts)	>60s
Peak temperature Tp	260°C
Time within peak temperature tp	10s
Ramp-down rate	5°C/s maximum

Soldering with hand soldering iron

- A. Hand soldering iron is only used for product rework or sample testing.
- B. Hand soldering iron requirements: Temperature: 360 °C+5°C within 3s.

Packing

Package Type	Packing Form	Quantity per Tube & Reel	Quantity per Box	Quantity per Carton	Antistatic Bag Specification	Box Specification	Carton Specification	Note
DIP4	Tube(500mm)	100 pcs/tube	50 tubes /box	10 boxes /ctn	190*670mm	520*105*50mm	545*372*235mm	Straight insert type material tube
SMD4	Reel(φ330mm)	2000 pcs/reel	2 reels /box	10 boxes /ctn	380*420mm	350*340*60mm	365*330*370mm	Guard band 200mm /min.

■ Summary table

■ DIP4 (Tube)

Qty/tube: 100pcs. Qty/box: 5000pcs.

Qty/ctn: 50000pcs.

Schematic: (unit : mm)

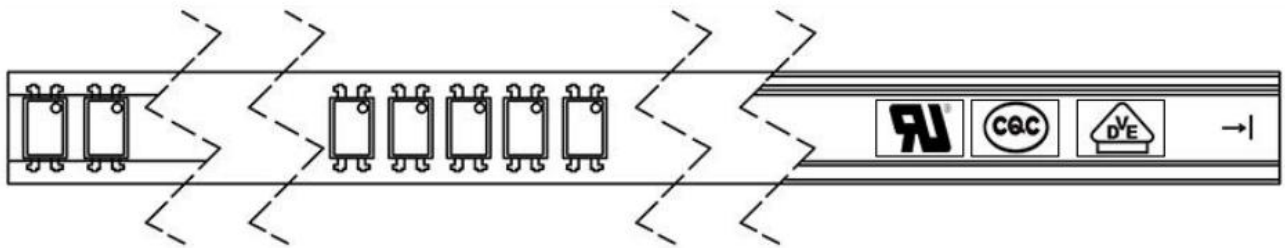

■ SMD4 (Reel)

Qty/reel: 2000pcs. Qty/box: 4000pcs.

Qty/ctn: 40000pcs.

Schematic: (unit : mm)

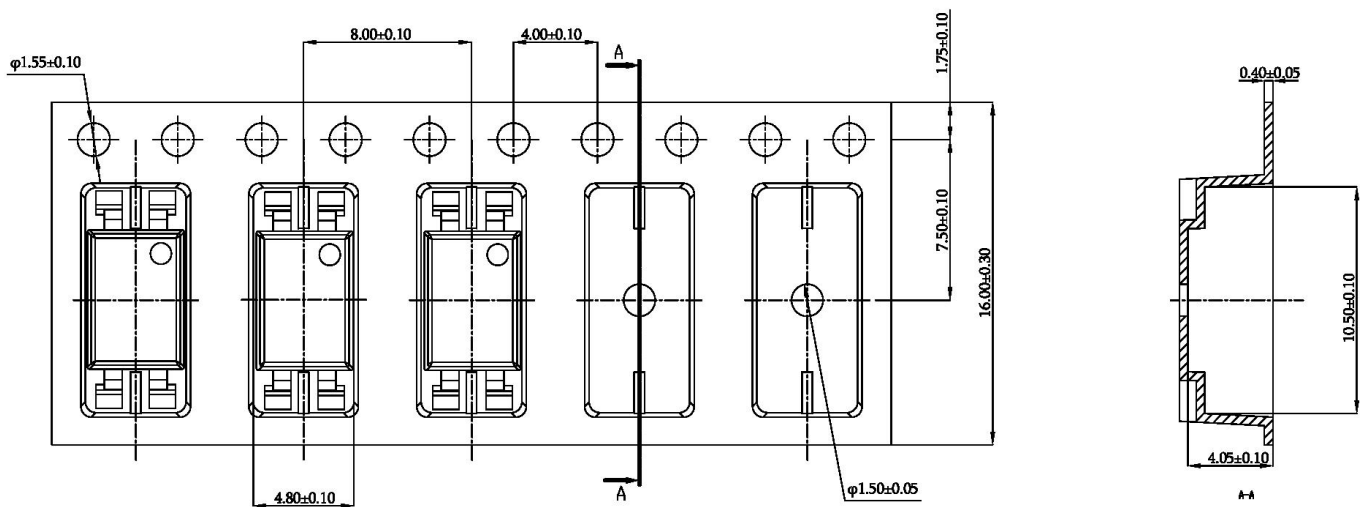

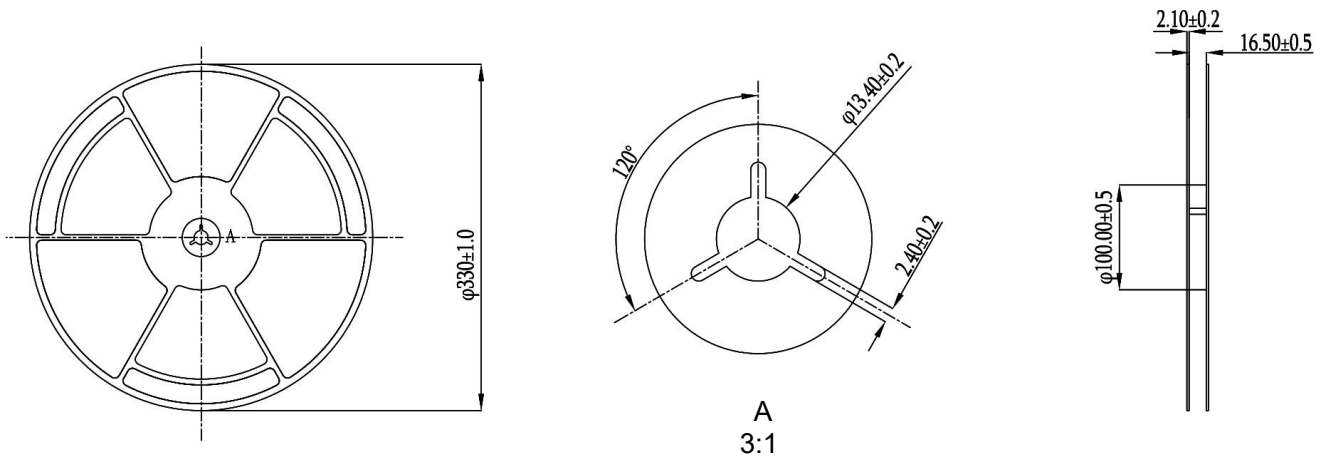

Attention

- XINGLIGHT implements dynamic technical updates. Specifications are subject to change. Refer to the official website for the latest version.
- Users must strictly adhere to specified conditions. Failures caused by misuse (overload, high temperature, incompatible circuits) are excluded from warranty.
- Contact technical support for customized validation in critical applications (medical devices, industrial control).
- This document is valid until Dec 31, 2026. Updates will be notified on the official website.
- For further clarification on technical specifications or application solutions, please contact us through official channels.