

### Product packaging logic diagram

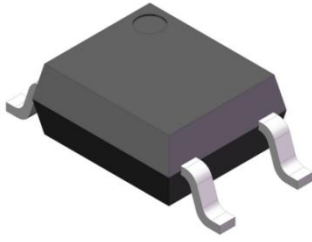

SOP4

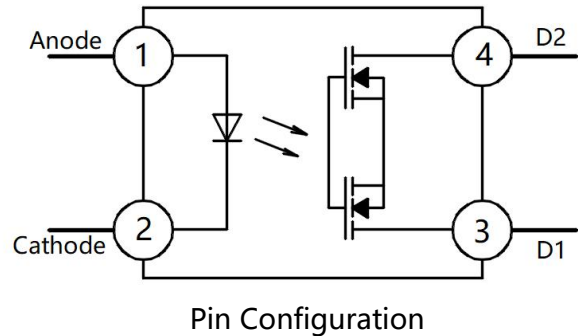

### Features

- Normally opened (SPST)
- High isolation voltage between input and output ( $V_{iso} = 3750V_{rms}$ )
- High sensitivity, low conductivity resistance
- Operating Temperature:  $-40^{\circ}C \sim 85^{\circ}C$
- Environmentally friendly products, compliant with CQC, UL, and VDE requirements

### Mechanical Data

- Case: SOP4
- Molding Compound: UL Flammability Classification Rating 94V-0
- Terminals: Matte tin-plated leads; solder ability-per MIL-STD-202, Method 208

### Applications

- Used for isolation and on-off control between main and control circuits of switching power supplies and industrial power modules, it achieves high-low voltage isolation and quickly triggers protection via signal transmission during overload or short circuit.
- Household Electric Appliances Applied to devices such as air conditioning, washing machines, smart homes, etc.
- Communication and Security: Switching signals in communication base stations and switches, and used for power control of monitoring cameras and access control systems.
- Medical equipment: Used for power management and signal processing of medical devices such as copiers and automatic disinfection equipment.



### Ordering Information

XL    M4401    (X)    (X)    -    (U)    (N)    (Y)  
 ①            ②            ③            ④                            ⑤            ⑥            ⑦

- ① Brand(XL)
- ② Product series (M4401)
- ③ Package type (S:SOP4)
- ④ Halogen option (None :Halogen free)
- ⑤ Lead frame (None: Copper)
- ⑥ Customer option 1 (0-9 or A-Z or none)
- ⑦ Customer option 2 (0-9 or A-Z or none)

Part Number	Package	Shipping Quantity	Marking Code
XLM4401	SOP4	3000pcs / Tape & Reel	XLM4401

### Marking Information

- " XL" denotes brand
- " M4401" denotes Product series
- " Y" denotes Year : A(2024), B(2025), C(2026)
- " WW" denotes Week' s number
- " N" denotes the day of Week.



### Maximum Ratings (@ T<sub>A</sub> = 25°C unless otherwise specified)

Parameter		Symbol	Value	Unit
Input	Forward Current	I <sub>F</sub>	50	mA
	Peak Forward Current *1	I <sub>FP</sub>	1	A
	Reverse Voltage	V <sub>R</sub>	5	V
	Power Dissipation	P <sub>D</sub>	75	mW
Output	Load Voltage (peak AC)	V <sub>L</sub>	60	V
	Continuous load current (peak AC)	I <sub>L</sub>	0.5	A
	Peak load current	I <sub>peak</sub>	1.5	A
	Power Dissipation	P <sub>Out</sub>	300	mW

### Thermal Characteristics

Parameter	Symbol	Value	Unit
Isolation Voltage *2	V <sub>ISO</sub>	3750	V <sub>rms</sub>
Operating Temperature	T <sub>OPR</sub>	-40 ~ +85	°C
Storage Temperature Range	T <sub>STG</sub>	-40 ~ +100	°C

**Notes:**

1. Pulse width ≤ 1μs, Duty ratio: 0.001
2. 40 to 60% RH, AC for 1 minute

### Electrical Characteristics (@ T<sub>A</sub> = 25°C unless otherwise specified)

Parameter		Symbol	Test Condition	Min.	Typ.	Max.	Unit
Input	LED turn on current	I <sub>Fon</sub>	I <sub>L</sub> =0.5A	-	0.4	3	mA
	LED turn off current	I <sub>Foff</sub>	I <sub>L</sub> =0.5A	-	0.3	3	mA
	LED dropout voltage	V <sub>F</sub>	I <sub>F</sub> =5mA	1	1.3	1.4	V
Output	On resistance	R <sub>on</sub>	I <sub>F</sub> =5mA, I <sub>L</sub> =0.5A, Within 1s on time	-	0.9	1.5	Ω
	Off state leakage current	I <sub>Leak</sub>	I <sub>F</sub> =0mA, V <sub>L</sub> =60V	-	-	1000	nA
Transfer Characteristics	Turn on time	T <sub>on</sub>	I <sub>F</sub> =5mA, I <sub>L</sub> =0.5A	-	0.17	2	ms
	Turn off time	T <sub>off</sub>	I <sub>F</sub> =5mA, I <sub>L</sub> =0.5A	-	0.14	1	ms
	I/O capacitance	C <sub>iso</sub>	f=1MHz, V <sub>B</sub> =0	-	0.8	1.5	pF
	Initial I/O isolation resistance	R <sub>iso</sub>	500V DC	1,000	-	-	MΩ

### Ratings and Characteristics Curves (@ $T_A = 25^\circ\text{C}$ unless otherwise specified)

Fig.1 Load current vs. Ambient temperature characteristics

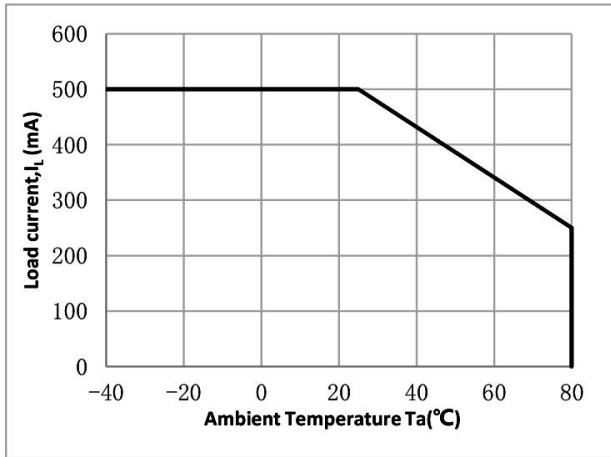

Fig.2 On resistance vs. Ambient temperature characteristics

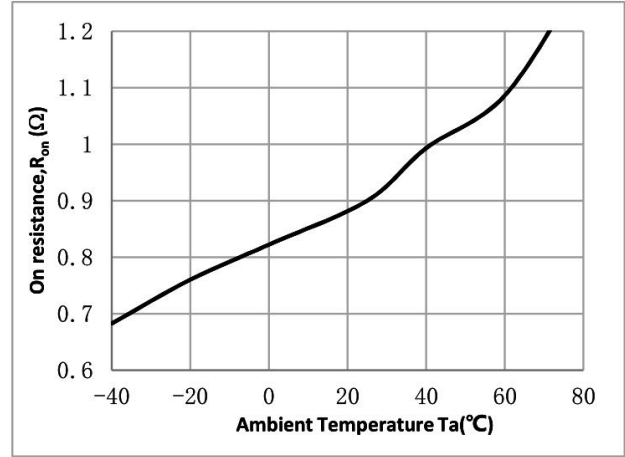

Fig.3 Turn on time vs. Ambient temperature characteristics

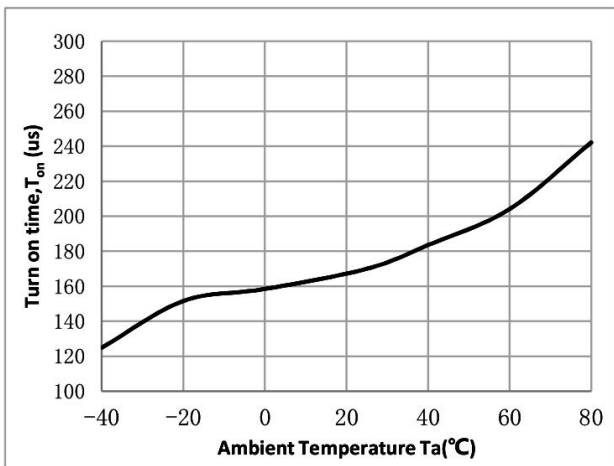

Fig.4 Turn off time vs. Ambient temperature characteristics

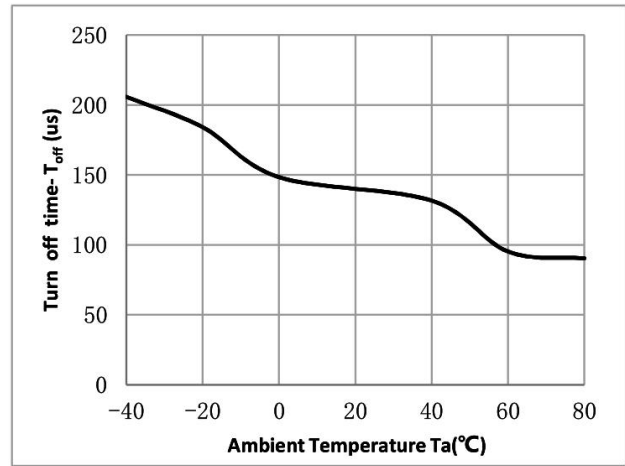

Fig.5 LED turn on current vs. Ambient temperature characteristics

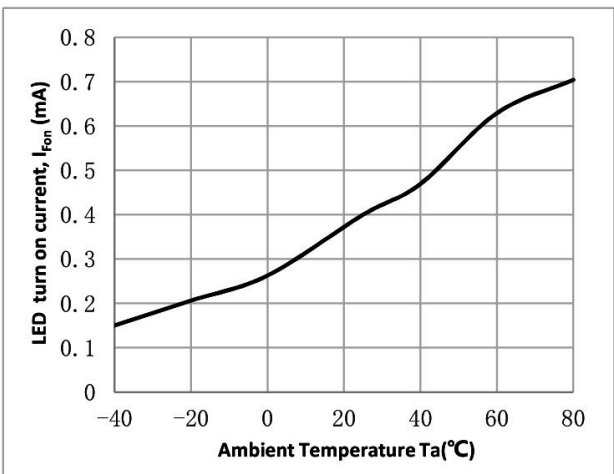
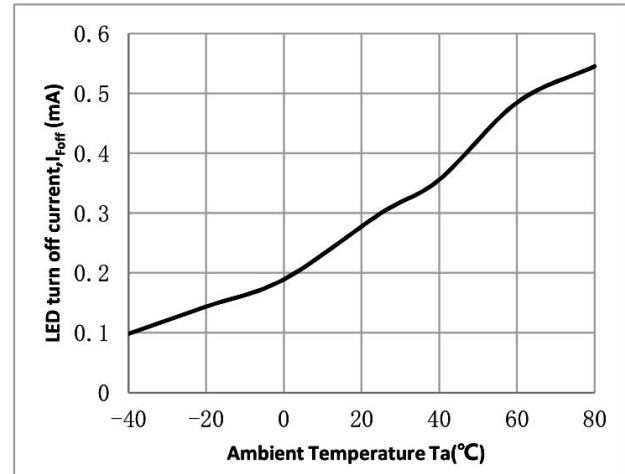

Fig.6 LED turn off current vs. Ambient temperature characteristics



### Ratings and Characteristics Curves (@ $T_A = 25^\circ\text{C}$ unless otherwise specified)

Fig.7 LED dropout voltage vs. Ambient temperature characteristics

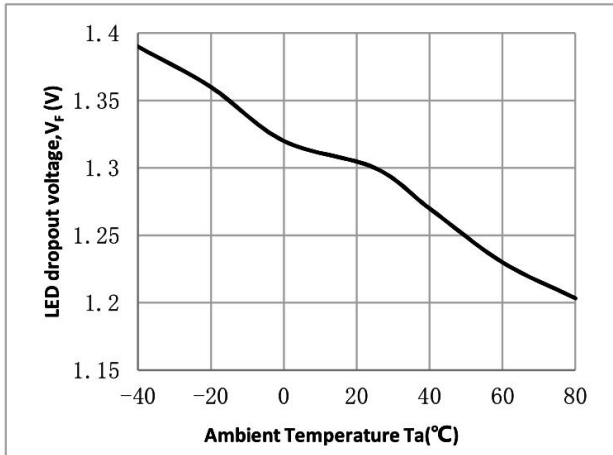

Fig.8 Output current vs Output voltage

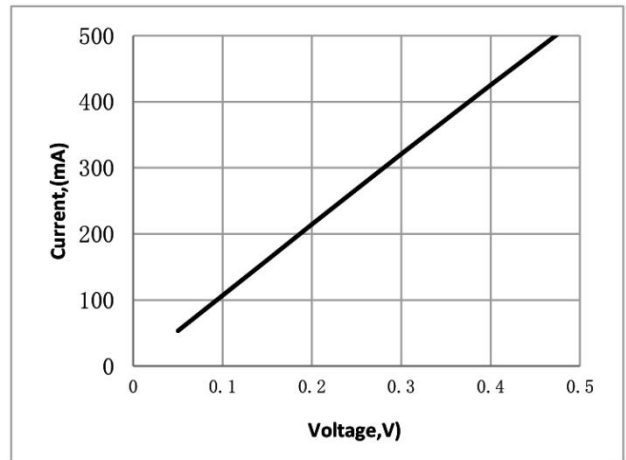

Fig.9 Off state leakage current vs Load voltage characteristics

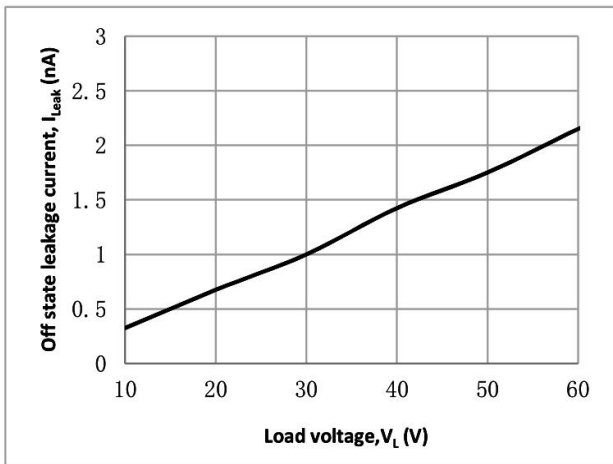

Fig.10 LED turn on time vs Forward current characteristics

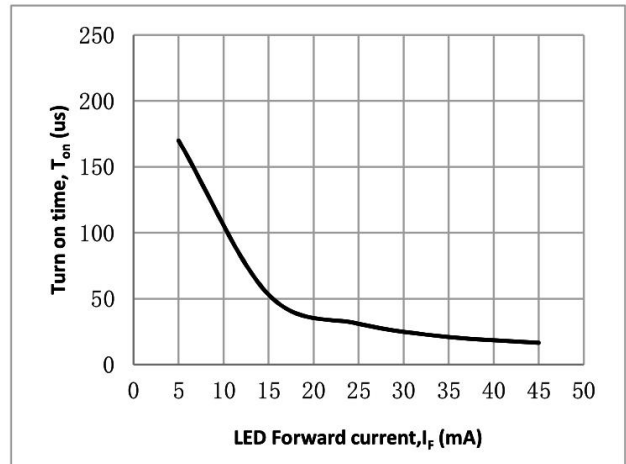

Fig.11 LED turn off time vs Forward current characteristics

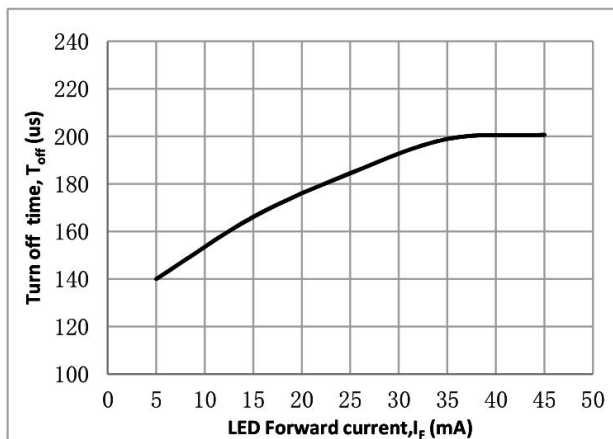
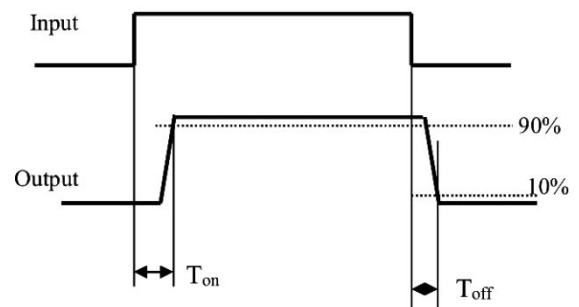
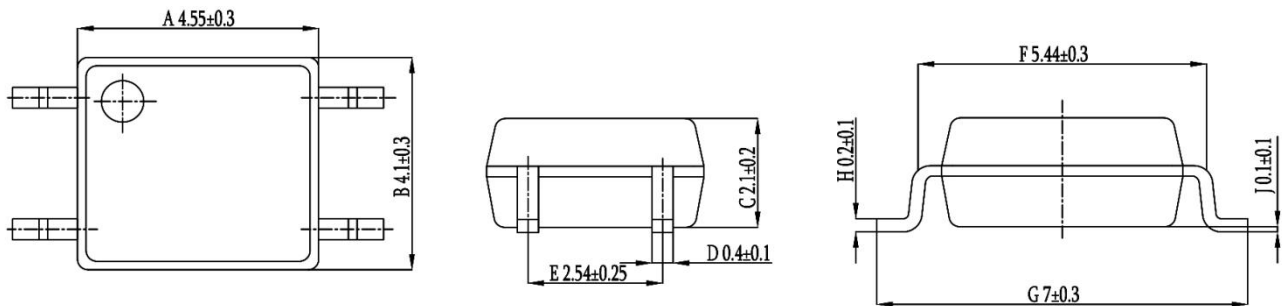

Fig.12 Turn on/off time



#### Package Outline Dimensions (unit: mm)

##### SOP4



#### SOLDERING FOOTPRINT (unit: mm)

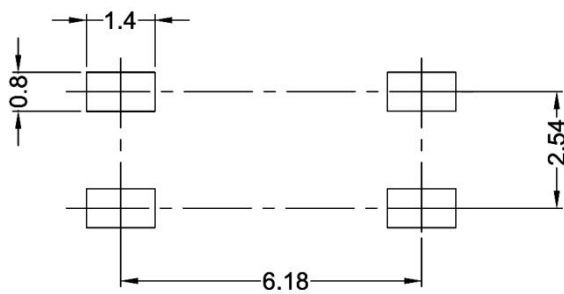

### Reflow soldering

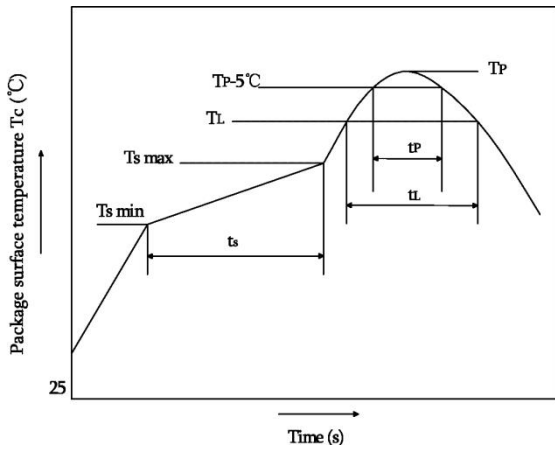

	Symbol	Min	Max	Unit
Preheat temperature	Ts	150	200	°C
Preheat time	ts	60	120	s
Ramp-up rate(TL to TP)			3	°C/s
Liquidus temperature	TL	217		°C
Time above TL	tL	60	150	s
Peak temperature	Tp		260	°C
Time during which Tc is between (TP-5) and TP	tp		30	s
Ramp-down rate(TP to TL)			6	°C/s

**Note:**

Reflow soldering is recommended at the temperatures and times shown, no more than three times.

### Wave soldering

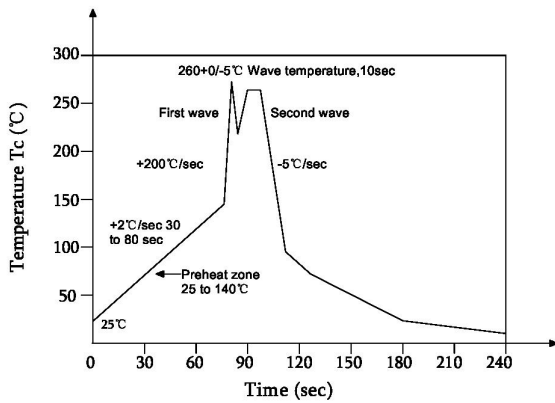

Profile feature	
Average ramp-up rate	~200°C/s
Heating rate during preheat	1°C/s to 2°C/s typical; 4°C/s maximum
Final preheat temperature Ts	~130°C
Preheat time (25°C to Ts)	>60s
Peak temperature Tp	260°C
Time within peak temperature tp	10s
Ramp-down rate	5°C/s maximum

### Soldering with hand soldering iron

- A. Hand soldering iron is only used for product rework or sample testing.
- B. Hand soldering iron requirements: Temperature: 360 °C±5°C within 3s.

#### Packing

Package Type	Packing Form	Quantity per Tube & Reel	Quantity per Box	Quantity per Carton	Antistatic Bag Specification	Box Specification	Carton Specification	Note
SOP4	Reel( $\phi 330$ mm)	3000 pcs/reel	2 reels /box	10 boxes /ctn	380*420mm	350*340*60mm	365*330*370mm	Leave 20 Spaces at the beginning and 50 Spaces at the end

- Summary table

- SOP4 (Reel)

Qty/reel: 3000pcs. Qty/box: 6000pcs.

Qty/ctn: 30000pcs.

Schematic: (unit: mm)

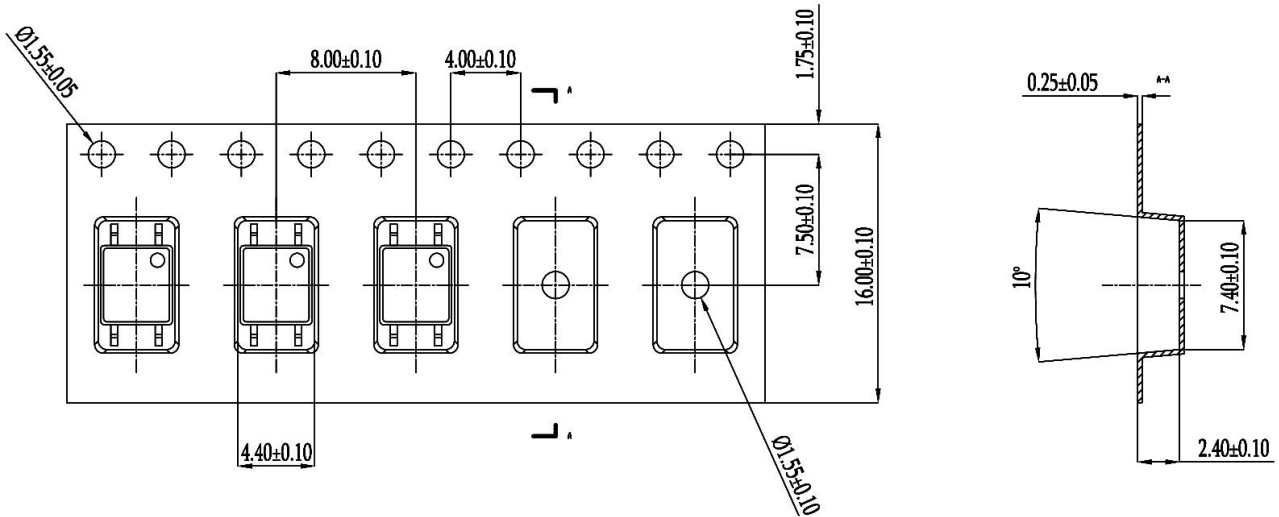

#### Attention

- XINGLIGHT implements dynamic technical updates. Specifications are subject to change. Refer to the official website for the latest version.
- Users must strictly adhere to specified conditions. Failures caused by misuse (overload, high temperature, incompatible circuits) are excluded from warranty.
- Contact technical support for customized validation in critical applications (medical devices, industrial control).
- This document is valid until Dec 31, 2026. Updates will be notified on the official website.
- For further clarification on technical specifications or application solutions, please contact us through official channels.