

**1204 白色 贴片式发光二极管****特点 (Characteristics) :**

- \* 外观尺寸 (L/W/H) :3.2\*1.0\*1.5mm  
Outline Dimensions (L / w / h): 3.2x 1.0x 1.5 mm
- \* 发光颜色及胶体: 白色/黄色胶体  
Luminous color and colloid: White/ Yellow colloid
- \* 环保工艺符合 ROHS 要求  
Environmental protection products Complied With ROHS Directive
- \* 湿气敏感性等级 (MSL) :3-4 级  
Moisture sensitivity level (MSL) : 3-4 levels
- \* EIA 规范标准包装  
EIA standard packaging
- \* 适用于 SMT 贴片自动化生产  
Suitable for SMT automatic production
- \* 适用于回流焊制程  
Suitable for reflow soldering process

**应用领域 (Product application) :**

- \*电子显示屏  
Electronic display screen,
- \*指示灯 pilot lamp,
- \*室内外照明  
Indoor and outdoor lighting;
- \*手机背光源 Mobile  
phone backlight,
- \*电子电器指示应用  
Application of electronic and electrical indication、
- \*手机数码产品 Mobile digital products

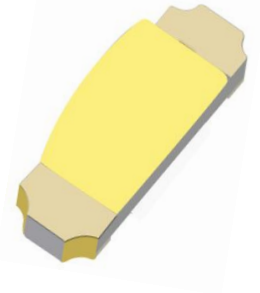

# 目录

## Catalogue

电性参数	
Electrical Characteristics.....	3
典型特性曲线	
Typical Characteristic Curves.....	8
可靠性实验	
Reliability Test Items And Conditions.....	9
外形尺寸	
Outline Dimensions.....	10
包装	
Packaging.....	11
焊接指导	
Guideline for Soldering.....	13
使用注意事项	
Precautions.....	15

## 电性参数

## Electrical Characteristics

## 极限参数 (Ta=25°C) Absolute Maximum Rating (ta=25 °C)

项目参数 Parameter	符号 Symbol	数值 Value	单位 Unit
最大功耗 (Max Power Dissipation)	PD	70	mW
最大正向电流 (Max Continuous Forward Current)	IF	20	mA
最大脉冲峰值电流 (Peak Forward Current)	IFP	80	mA
最大反向电压 (Max Reverse Voltage)	VR	5	V
抗静电能力 (Antistatic ability)	ESD	2000	V
工作环境 (Operating Temperature Range)	TOPR	-40 ~ +85 °C	°C
储存温度 (Storage Temperature Range)	TSTR	-40 ~ +85 °C	°C
焊接温度/时间 (Lead Soldering Temperature/Time)	TSOL	260°C ≤ 6S	/

\* 注: 脉冲宽度 ≤ 0.1ms, 占空比 ≤ 1/10

\* Note: Pulse width ≤ 0.1ms, Duty ≤ 1/10

## 光电参数 (Ta=25°C) Optical-electrical parameter (ta=25 °C)

项目参数 Parameter	符号 Symbol	最小值 Min.	一般值 Typ.	最大值 Max.	单位 Unit	测试条件 Test conditions
发光强度 (Luminous Intensity)	Iv	450	---	1000	mcd	IF=20mA
色温 (Color temperature)	TC	8000	/	12000	K	IF=20mA
坐标值 (Coordinate value)	X	/	/	/	---	IF=20mA
	Y	/	/	/	---	IF=20mA
正向电压 (Forward Voltage)	VF	2.7	---	3.3	V	IF=20mA
发光角度 (Viewing Angle)	2 θ 1/2	---	120	---	Deg	IF=20mA
反向电流 (Reverse Current)	IR	---	---	1	μA	VR=5V

**亮度分档:**

**Brightness grading:**

代码 Code	最小值 Min	最大值 Max	单位 Unit	测试条件 Test conditions
E3	450	500	mcd	IF=20mA
E4	500	550		
E5	550	600		
E6	600	700		
E7	700	800		
E8	800	900		
E9	900	1000		

**电压分档:**

**Voltage grading:**

代码 Code	最小值 Min	最大值 Max	单位 Unit	测试条件 Test conditions
N11-8	2.7	2.9	V	IF=20mA
N11-9	2.9	3.1		
N12-1	3.1	3.3		

**色区代码:**

**Color zone code:**

主产色区 Main Color Zone	代码 Code
<b>D3</b>	<b>CW1-20</b>
<b>C3</b>	<b>CW3-20</b>
<b>B3</b>	<b>CW4-21</b>

色区:  
Color zone

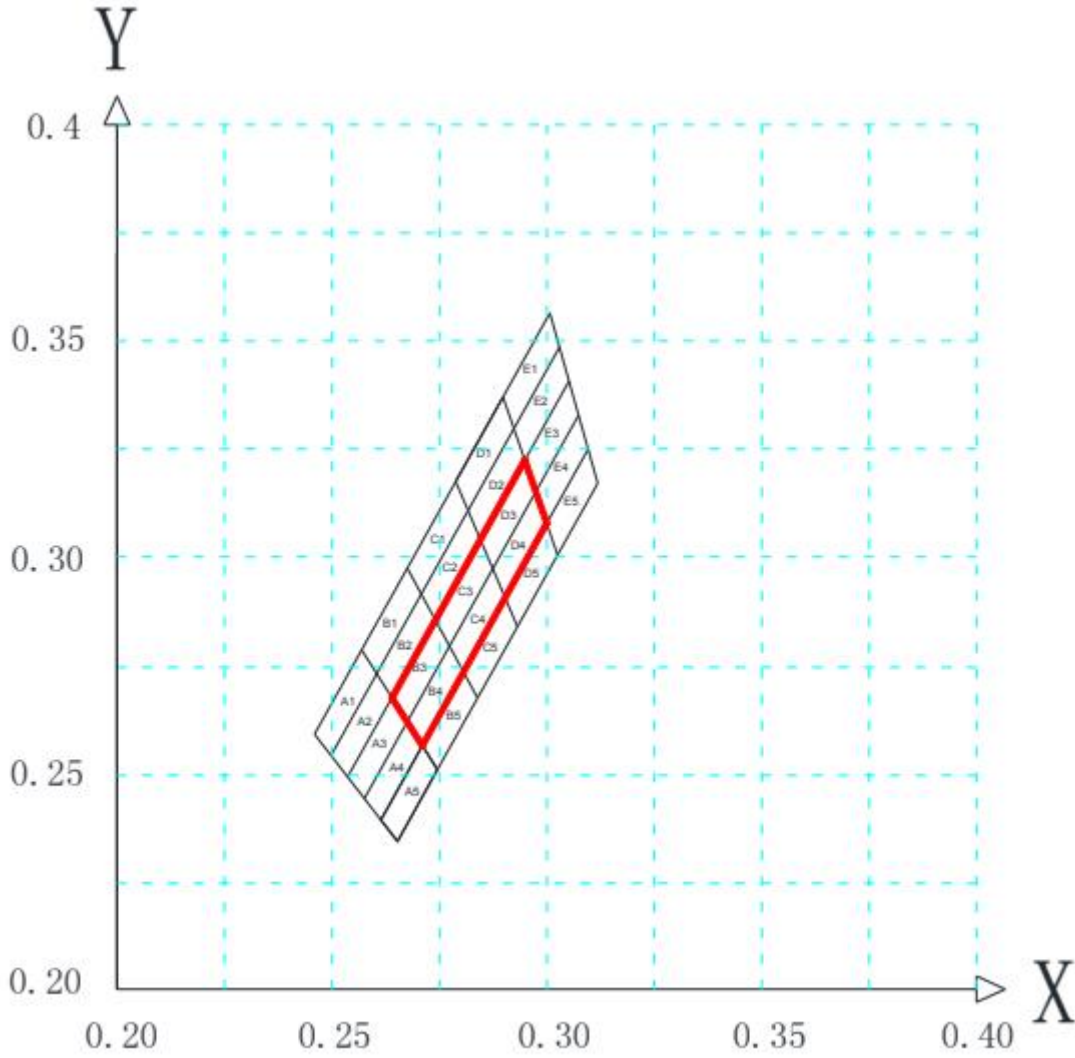

备注：红色部分为主产色区

Note: the red part is the main color producing area

色坐标:

Bin Code	CIE-X	CIE-Y	Bin Code	CIE-X	CIE-Y	Bin Code	CIE-X	CIE-Y
A1	0.2459	0.259	B1	0.2569	0.2785	C1	0.2675	0.2974
	0.2569	0.2785		0.2675	0.2974		0.2788	0.3175
	0.2604	0.273		0.2708	0.2914		0.2817	0.3108
	0.2498	0.2541		0.2604	0.273		0.2708	0.2914
	0.2459	0.259		0.2569	0.2785		0.2675	0.2974
A2	0.2498	0.2541	B2	0.2604	0.273	C2	0.2708	0.2914
	0.2604	0.273		0.2708	0.2914		0.2817	0.3108
	0.264	0.2674		0.2741	0.2854		0.2846	0.3041
	0.2537	0.2491		0.264	0.2674		0.2741	0.2854
	0.2498	0.2541		0.2604	0.273		0.2708	0.2914
A3	0.2537	0.2491	B3	0.264	0.2674	C3	0.2741	0.2854
	0.264	0.2674		0.2741	0.2854		0.2846	0.3041
	0.2675	0.2619		0.2773	0.2794		0.2874	0.2973
	0.2575	0.2441		0.2675	0.2619		0.2773	0.2794
	0.2537	0.2491		0.264	0.2674		0.2741	0.2854
A4	0.2575	0.2441	B4	0.2675	0.2619	C4	0.2773	0.2794
	0.2675	0.2619		0.2773	0.2794		0.2874	0.2973
	0.271	0.2563		0.2806	0.2734		0.2903	0.2906
	0.2614	0.2392		0.271	0.2563		0.2806	0.2734
	0.2575	0.2441		0.2675	0.2619		0.2773	0.2794
A5	0.2614	0.2392	B5	0.271	0.2563	C5	0.2806	0.2734
	0.271	0.2563		0.2806	0.2734		0.2903	0.2906
	0.2746	0.2508		0.2839	0.2673		0.2932	0.2839
	0.2653	0.2342		0.2746	0.2508		0.2839	0.2673
	0.2614	0.2392		0.271	0.2563		0.2806	0.2734

Bin Code	CIE-X	CIE-Y	Bin Code	CIE-X	CIE-Y
D1	0.2788	0.3175	E1	0.2898	0.337
	0.2898	0.337		0.3007	0.3565
	0.2923	0.3297		0.303	0.3486
	0.2817	0.3108		0.2923	0.3297
	0.2788	0.3175		0.2898	0.337
D2	0.2817	0.3108	E2	0.2923	0.3297
	0.2923	0.3297		0.303	0.3486
	0.2949	0.3224		0.3052	0.3407
	0.2846	0.3041		0.2949	0.3224
	0.2817	0.3108		0.2923	0.3297
D3	0.2846	0.3041	E3	0.2949	0.3224
	0.2949	0.3224		0.3052	0.3407
	0.2974	0.3151		0.3074	0.3328
	0.2874	0.2973		0.2974	0.3151
	0.2846	0.3041		0.2949	0.3224
D4	0.2874	0.2973	E4	0.2974	0.3151
	0.2974	0.3151		0.3074	0.3328
	0.3	0.3078		0.3096	0.3249
	0.2903	0.2906		0.3	0.3078
	0.2874	0.2973		0.2974	0.3151
D5	0.2903	0.2906	E5	0.3	0.3078
	0.3	0.3078		0.3096	0.3249
	0.3025	0.3005		0.3118	0.317
	0.2932	0.2839		0.3025	0.3005
	0.2903	0.2906		0.3	0.3078



典型特性曲线

Typical Characteristics Curves

光谱分布曲线  
Relative Spectral Distribution

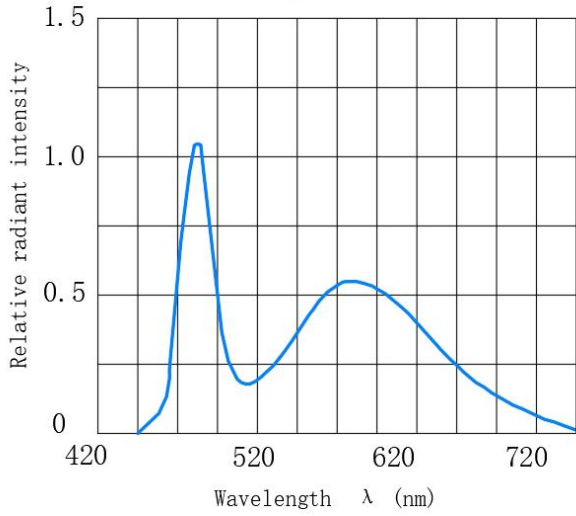

伏安特性  
Volt ampere characteristic

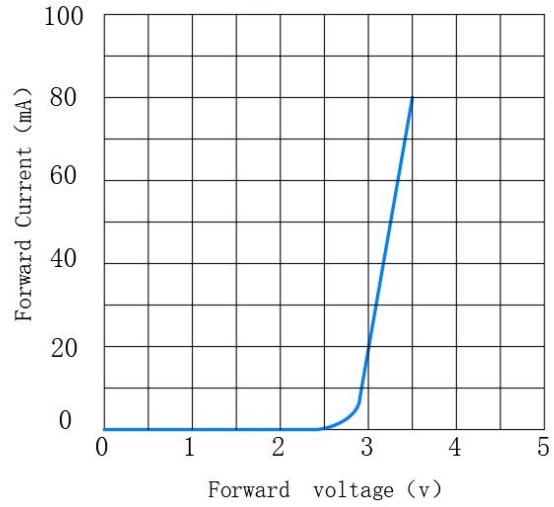

正向电流降额曲线  
Forward current derating curve

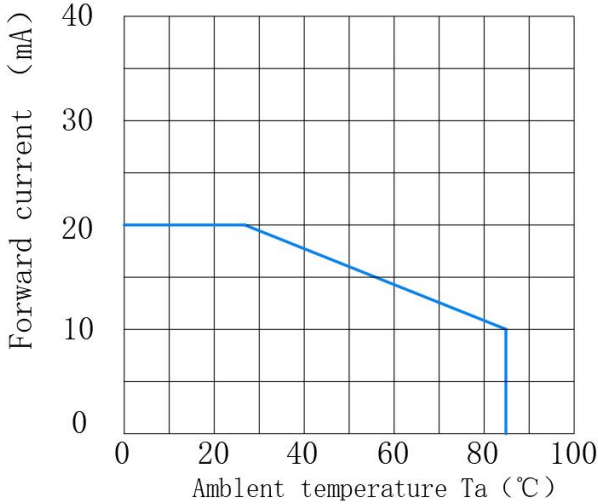

相对光强与正向电流特性  
Relative Luminous VS Forward Current

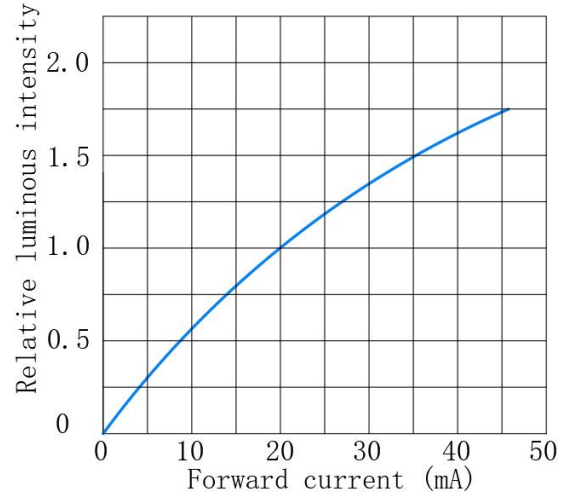

光强与环境温度曲线  
Luminous Intensity VS Ambient Temperature

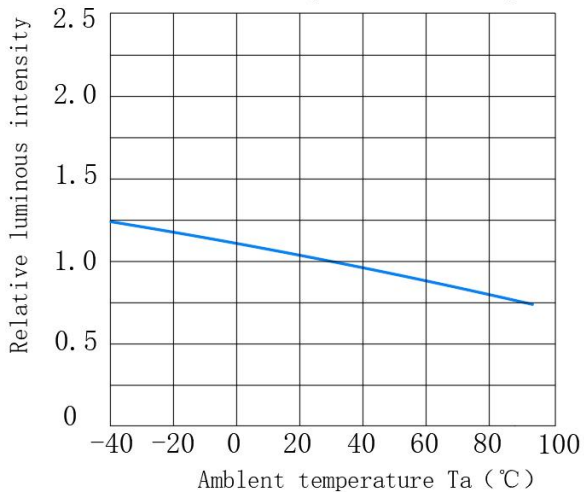

相对辐射强度与空间角度关系  
Radiation diagram

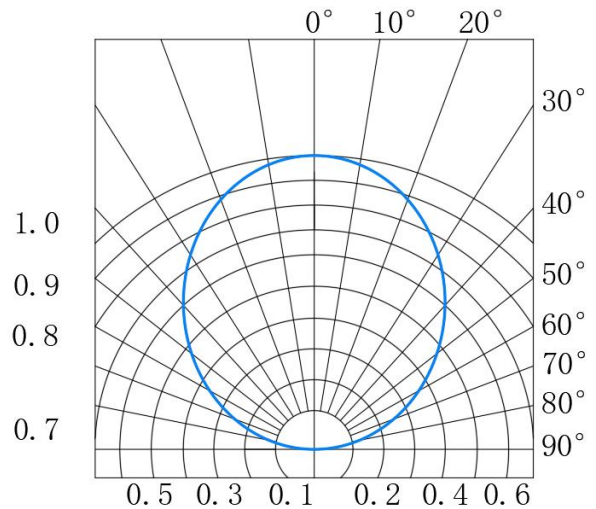

注：如无另外注明，测试环境温度为 25±5°C/Note: If not otherwise indicated the test environment temperature is 25±5°C



## 可靠性试验

### Reliability Test Items And Conditions

类别 Class	测试项目 Test item	测试环境 Testing environment	测试时间 Testing time	参考标准 Reference standard
耐久性测试 Endurance test	工作寿命 Working life	室温条件下以最大额定电流持续点亮; 以 20mA 测试 (Continuous lighting at the maximum rated current at room	1000 小时 1000 hours (-24 小时, +72 小 时) (-24hours, )	MIL-STD-750D:1026 MIL-STD-883D:1005 JIS C 7021:B-1
	高温高湿储存 High temperature and high humidity	IR-Reflow In-Board, 2 Times 环境温度Ta= 85±5℃, 相对湿度RH= 90~95%	240 小时 240hours (± 2 小时) (± 2hours)	MIL-STD-202F:103B JIS C 7021:B-11
	高温储存 High-temperatur e storage	环境温度Ta= 85±5℃	1000 小时 1000 hours (-24小时 +72小时) (-24hours+72hours )	MIL-STD-883D:1008 JIS C 7021:B-10
	低温储存Low temperature	环境温度 Ta= -40±5℃		JIS C 7021:B-12
环境测试 Environme ntal testing	冷热循环 Cold and hot cycle	105℃ ~ 25℃ ~ -55℃ ~ 25℃ 30mins 5mins 30mins 5mins	100 次 循环 100 Circles	MIL-STD-202F:107D MIL-STD-750D:1051 MIL-STD-883D:1010
	冷热冲击 Hot and cold impact	IR-Reflow In-Board, 2 Times; 100± 5℃ ~ -40℃ ± 5℃; 20mins ; 20mins	100 次 循环 100 Circles	MIL-STD-202F:107D MIL-STD-750D:1051 MIL-STD-883D:1011
	抗锡试验 Anti-tin test	焊锡温度 T. sol= 260 ± 5℃	10 ± 1secs 2 次 2times	MIL-STD-202F:210A MIL-STD-750D:2031
	红外回流焊 无铅制程 Infrared reflowwelding There is lead process	升温速度 heat up speed(183℃到最高值) : 最大 3℃/秒; 维持温度 keep temperature 在 125(±25)℃: 不超过 120 秒; 维持温度 keep temperature 在 183℃以上: 60-150 秒 最高温度限制范围maximum temperature: 235℃+5/-0℃; 维持keep在235℃+5/-0℃时 间: 10-15 秒; 降温速度cooling rate: 最	-----	MIL-STD-750D:2031. 2 J-STD-020C
	红外回流焊 无铅制程 Infrared reflow welding Lead-free process	升温速度 heat up speed(217℃到最高值) : 最大 3℃/秒; 维持温度 keep temperature 在 175(±25)℃: 不超过 180 秒; 维持温度 keep temperature 在 217℃以上: 60-120 秒 最高温度限制范围maximum temperature: 255℃+0/-5℃; 维持keep在255℃+0/-5℃时 间: 5-10秒; 降温速度cooling rate: 最大6℃	-----	MIL-STD-750D:2031. 2 J-STD-020C
可焊性试验 Weldability test	焊锡温度 Soldering temperature T. sol= 235 ± 5℃; 浸入速度 Immersion speed: 25±2.5 mm/秒; 上锡率 ≥95% 焊盘面积; Tin loading rate ≥ 95% pad area Immersion time: 2 ± 0.5 seconds	浸入时间 Immersion time: 2± 0.5 秒	MIL-STD-202F:208D MIL-STD-750D:2026 MIL-STD-883D:2003 IEC 68 Part 2-20 JIS C 7021:A-2	

## 外形尺寸

### Outline Dimension

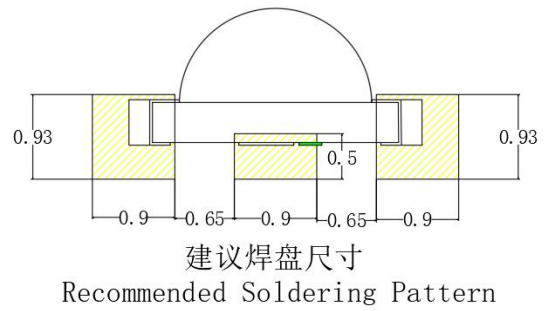
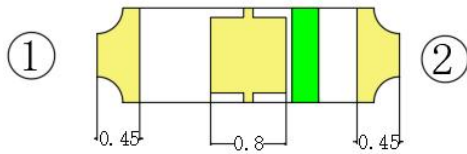
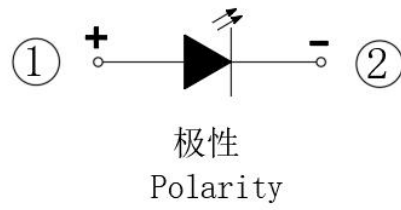
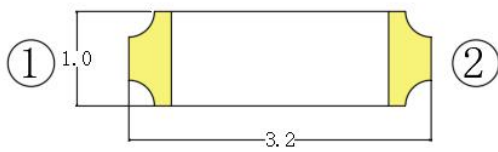
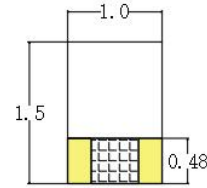
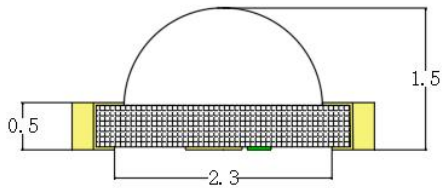

备注: 1. 以上尺寸单位均为 mm  
Remarks: All dimensions are in millimeters.

2. 未特别标注公差尺寸公差均为 ±0.25mm  
Tolerance is ±0.25mm unless otherwise noted

## 包装 (1)

### Packaging (1)

#### 载带与圆盘尺寸 Belt and disk dimensions

#### 载带与圆盘尺寸 Belt and disk dimensions

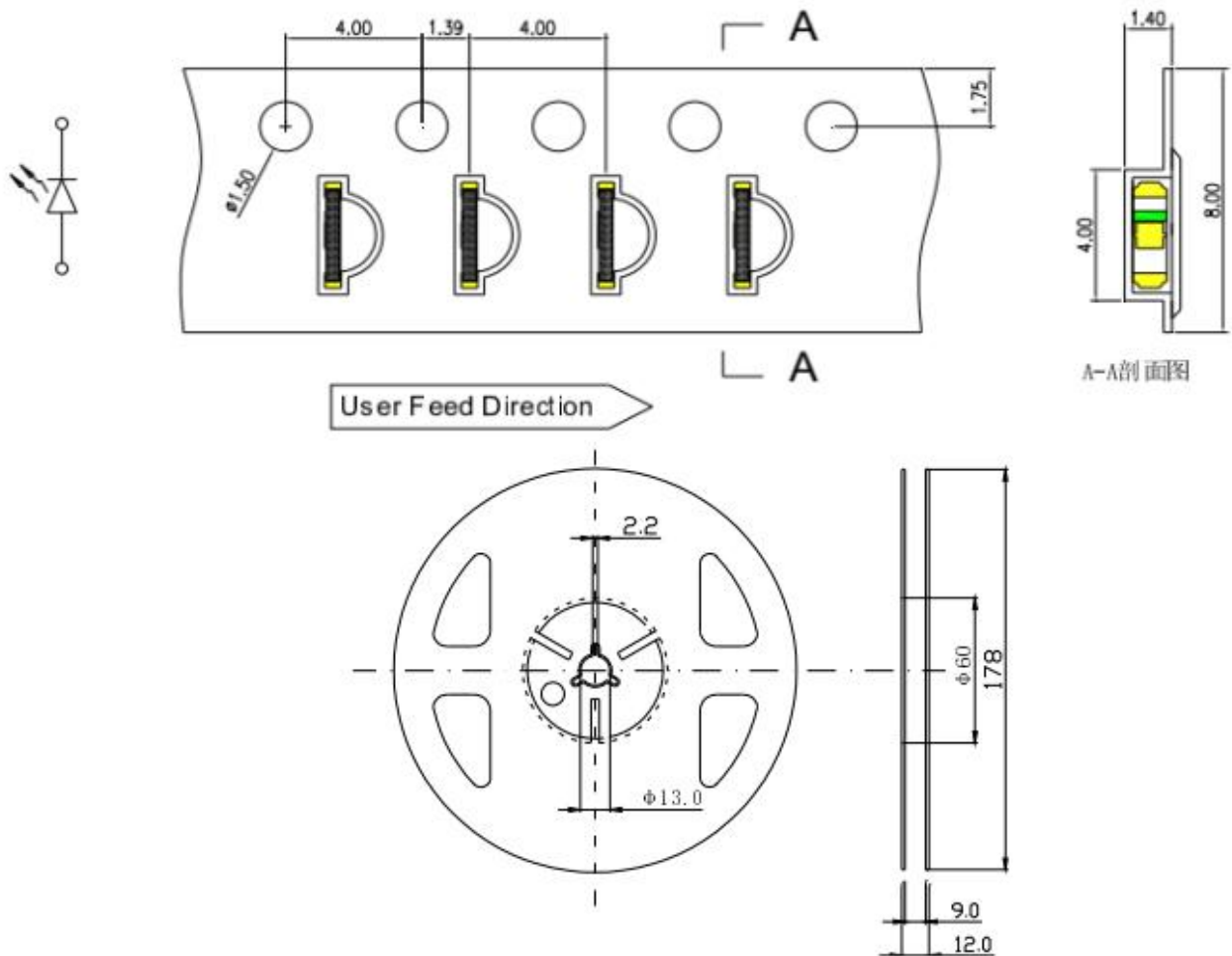

单位: mm, 未注公差:  $\pm 0.1$  mm

All dimensions in mm, tolerances unless mentioned is  $\pm 0.1$  mm.

#### ◇ 圆盘及载带卷出方向及空穴规格 Disk and carrier belt direction of roll and hole dimensions

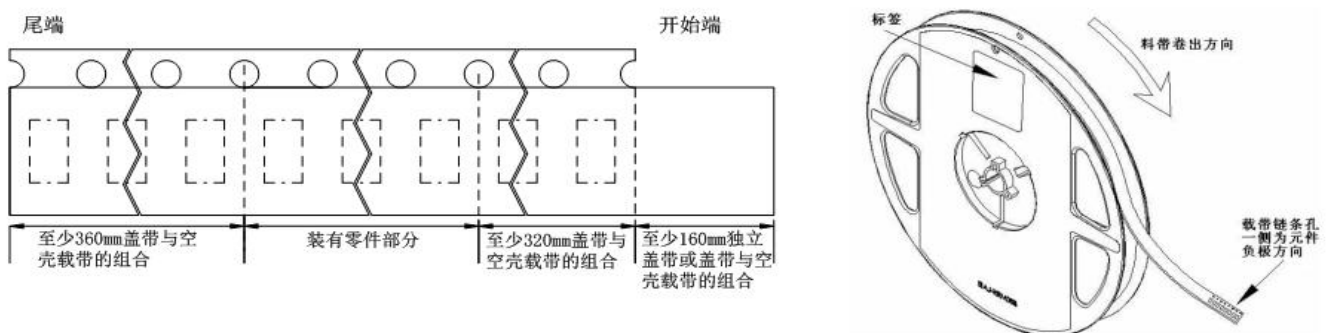

## 包装 (2)

### Packaging (2)

#### ◇ 防潮防静电包装 Moisture Proof and Anti-Electrostatic Foil Bag

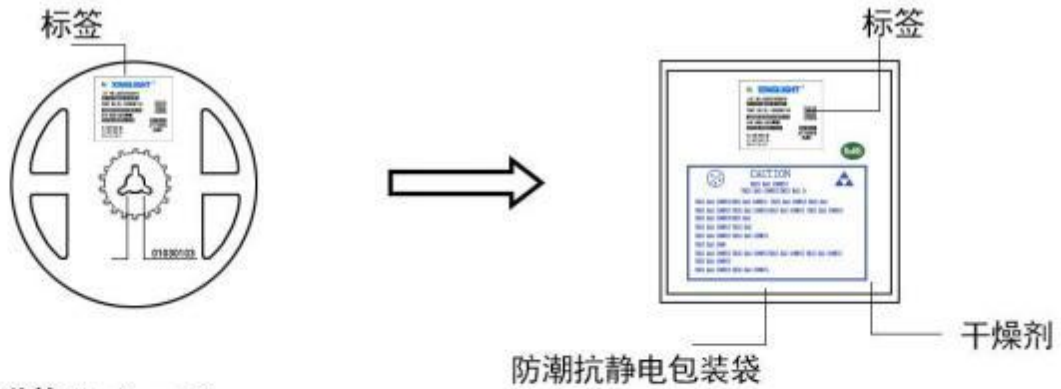

#### ◇ 外包装箱 Cardboard Box

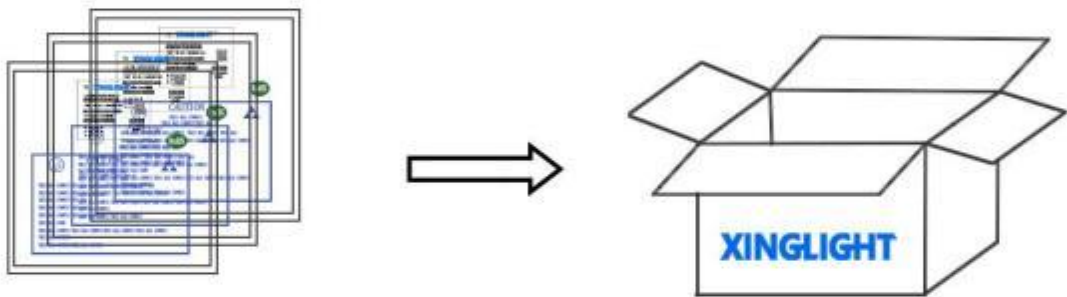

Capacity 5 or 10 reels per box (内箱容量: 50或100卷)

#### ◇ 标签说明: Label Explanation

- LOT NO: 批次信息
- PART NO: 产品型号
- BIN CODE: 产品名称
- WL: 波长范围
- IV: 光强范围
- VF: 电压范围



## 焊接指导 (1)

### Guideline for Soldering (1)

#### 1. 使用烙铁人手焊接

##### Hand Soldering

只建议在修理和重工的情况下使用手工焊接；推荐使用功率低于 30 W 的烙铁，焊接时烙铁的温度必须保持在 300℃ 以下，且每个电极只能进行一次焊接，每次焊接的持续时间不得超过 3 秒。

人手焊接过程中的不慎操作易引起 LED 产品的损坏，应当小心谨慎。

Manual welding is recommended only for repair and heavy industry situations. A soldering iron of less than 30W is recommended to be used in Hand Soldering. Please keep the temperature of the soldering iron under 300°C while soldering. Each terminal of the LED is to go for less than 3 second and for one time only.

Be careful because the damage of the product is often started at the time of the hand soldering.

#### 2. 回流焊接： 推荐使用以下无铅回流焊接温度图进行。

**Reflow Soldering:** Use the conditions shown in the under Figure of Pb -Free Reflow Soldering.

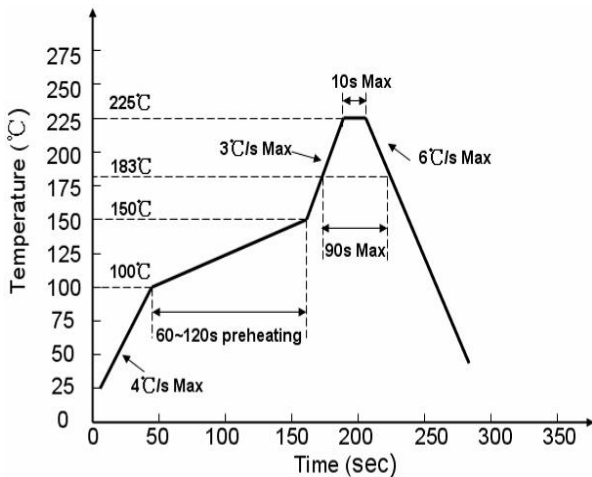

有铅制程 Lead process

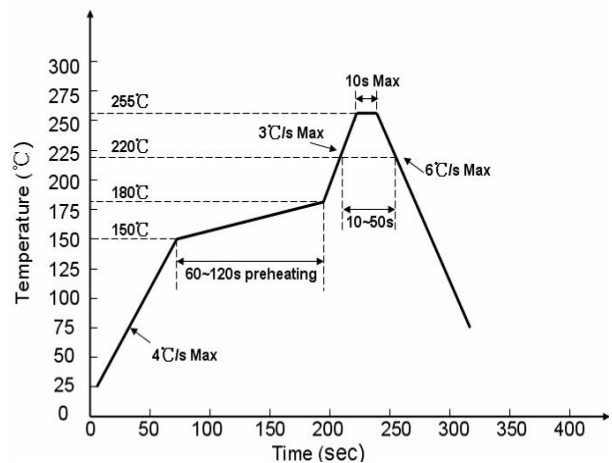

无铅制程 lead free

回流焊接最多只能进行两次。

Reflow soldering should not be done more than two times.

在回流焊接升温过程中，请不要对 LED 施加任何压力。

Stress on the LEDs should be avoided during heating in soldering process.

在焊接完成后，待产品温度下降到室温之后，再进行其他处理。

After soldering, do not deal with the product before its temperature drop down to room temperature.

---

## 焊接指导 (2)

---

### Guideline for Soldering (2)

#### 3. 清洗:

##### Cleaning

在焊接后推荐使用酒精进行清洗，在温度不高于 30°C 的条件下持续 3 分钟，不高于 50°C 的条件下持续 30 秒。

使用其他类似溶剂清洗前，请先确认使用的溶剂不会对 LED 的封装和环氧树脂部分造成损伤。超声波清洗也是有效的方法，一般最大功率不应超过 300W，否则可能对 LED 造成损伤。请根据具体的情况预先测试清洗条件是否会对 LED 造成损伤。

It is recommended that alcohol be used as a solvent for cleaning after soldering. Cleaning is to go under 30°C for 3 minutes or 50°C for 30 seconds. When using other solvents, it should be confirmed beforehand whether the solvents will dissolve the package and the resin or not.

Ultrasonic cleaning is also an effective way for cleaning. But the influence of Ultrasonic cleaning on LED depends on factors such as ultrasonic power. Generally, the ultrasonic power should not be higher than 300W. Before cleaning, a pretest should be done to confirm whether any damage to LEDs will occur.

**\* 注意：** 此一般指导原则并不适用于所有 PCB 设计和焊接设备的配置。具体工艺受到诸多因素的影响，请根据特定的 PCB 设计和焊接设备来确定焊接方案。

**\* Note:** This general guideline may not apply to all PCB designs and configurations of all soldering equipment. The technics in practise is influenced by many factors, it should be specialized base on the PCB designs and configurations of the soldering equipment..



---

## 使用注意事项（1）

---

### Precautions (1)

#### 1. 贮存:

##### Storage

- 本产品使用密封防潮抗静电袋包装，并附有干燥剂，未开封的产品有一年的保存时间。

Moisture proof and anti-electrostatic package with moisture absorbent material is used, to keep moisture to a minimum.

- 开封前，产品须存放在温度不高于 30℃，湿度不高于 60%RH 的环境中。

Before opening the package, the product should be kept at 30℃ or less and humidity less than 60% RH, and be used within a year.

- 开封后，产品须存放在温度不高于 30℃，湿度不高于 40%RH 的环境中，且应该在 168 小时（7 天）内使用完。建议工作环境为温度不高于 30℃，湿度不高于 60%RH。

After opening the package, the product should be stored at 30℃ or less and humidity less than 40%RH, and be soldered within 168 hours (7 days). It is recommended that the product be operated at the workshop condition of 30℃ or less and humidity less than 60%RH.

- 对于尚未焊接的 LED，如果吸湿剂或包装失效，或者产品没有符合以上有效存储条件，烘焙可以起到一定的性能恢复效果。烘焙条件：60±5℃，持续24 小时。

If the moisture absorbent material has fade away or the LEDs have exceeded the storage time, baking treatment should be performed based on the following condition: (60±5)℃ for 24 hours.

#### 2. 静电:

##### Static Electricity

静电和电涌会导致产品特性发生改变，例如正向电压降低等，如果情况严重甚至会损毁产品。所以在使用时必须采取有效的防静电措施。所有相关的设备和机器都应该正确接地，同时必须采取其他防止静电和电涌的措施。使用防静电手环，防静电垫子，防静电工作服、工作鞋、手套，防静电容器，都是有效的防止静电和电涌的措施。

Static electricity or surge voltage damages the LEDs. Damaged LEDs will show some unusual characteristic such as the forward voltage becomes lower, or the LEDs do not light at the low current. even not light.

All devices, equipment and machinery must be properly grounded. At the same time, it is recommended that wrist bands or anti-electrostatic gloves, anti-electrostatic containers be used when dealing with the LEDs.

## 使用注意事项 (2)

### Precautions (2)

#### 3. 设计建议:

##### Design Consideration

设计电路时, 通过 LED 的电流不能超过规定的最大值, 同时, 还需使用保护电阻, 否则, 微小的电压变化将会引起较大的电流变化, 可能导致产品损毁。

建议使用以下 (A) 电路, 该电路能够很好的调节通过每个 LED 的电流; 不推荐使用 (B) 电路, 该电路在持续的电压驱动下, LED 的正向电压 ( $V_F$ ) 发生变化, 电流会随之而发生变化, 可能使某些 LED 承受高于规定的电流值。

In designing a circuit, the current through each LED must not exceed the absolute maximum rating specified for each LED. In the meanwhile, resistors for protection should be applied, otherwise slight voltage shift will cause big current change, burn out may happen.

It is recommended to use Circuit A which regulates the current flowing through each LED rather than Circuit B. When driving LEDs with a constant voltage in Circuit B, the current through the LEDs may vary due to the variation in Forward Voltage ( $V_F$ ) of the LEDs. In the worst case, some LED may be subjected to stresses in excess of the Absolute Maximum Rating.

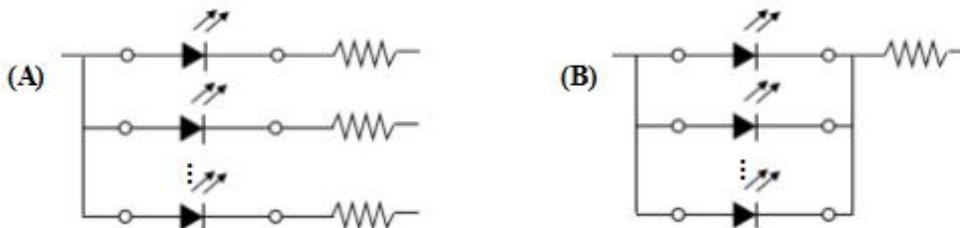

LED 的特性容易因为自身的发热和环境的温度的改变而发生改变。温度的升高会降低 LED 的发光效率、影响发光颜色等, 所以在设计时应充分考虑散热的问题。

Thermal Design is paramount importance because heat generation may result in the Characteristics decline, such as brightness decreased, Color changed and so on. Please consider the heat generation of the LEDs when making the system design.

## 使用注意事项 (3)

### Precautions (3)

#### 4. 其他事项:

##### Others

直接用手拿取产品不但会污染封装树脂表面,也可能由于静电等因素导致产品性能的改变。过度的压力也可能直接爆响封装内部的管芯和金线,因此请勿对产品施加过度压力,特别当产品处于高温状态下,例如在回流焊接过程中。

When handling the product, touching the encapsulant with bare hands will not only contaminate its surface, but also affect on its optical characteristics. Excessive force to the encapsulant might result in catastrophic failure of the LEDs due to die breakage or wire deformation. For this reason, please do not put excessive stress on LEDs, especially when the LEDs are heated such as during Reflow Soldering.

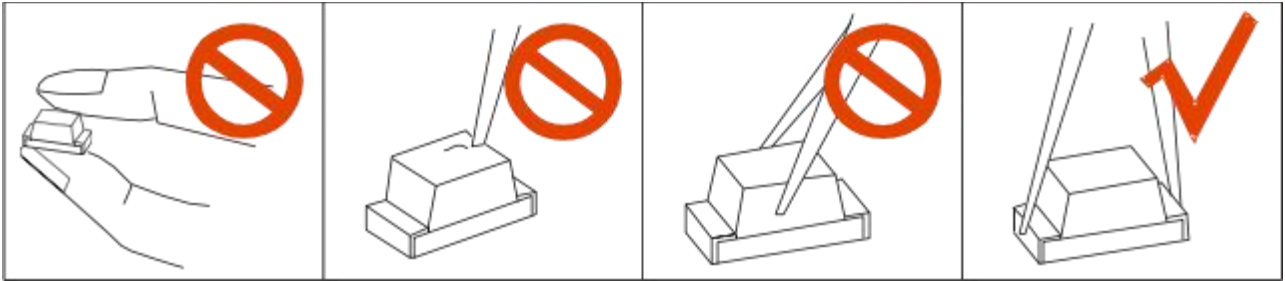

LED 的环氧树脂封装部分相当脆弱,请勿用坚硬、尖锐的物体刮、擦封装树脂部分。在用镊子夹取的时候也应当小心注意。

The epoxy resin of encapsulant is fragile, so please avoid scratch or friction over the epoxy resin surface.

While handling the product with tweezers, do not hold by the epoxy resin, be careful.

#### 5. 眼睛保护忠告:

##### Safety Advice For Human Eyes

LED 发光时,请勿直视发光光源,特别是对于一些光强较高的 LED,强光可能伤害你的眼睛。

Viewing direct to the light emitting center of the LEDs, especially those of great Luminous Intensity, will cause great hazard to human eyes. Please be careful.